

Obrigado por utilizar os produtos Think Technology.
Assim você tem a certeza de estar usando produtos originais e de alta qualidade.

1. Siga as instruções deste manual para uma correta montagem do conector. Não nos responsabilizamos por problemas devido manuseio e/ou instalação incorreta do produto;
2. Use o conector de acordo com o tipo de cabo adequado;
3. Cuidado ao realizar a montagem do conector em altura. Sugere-se utilizar uma plataforma de trabalho da Think Technology para suporte de ferramentas.

COMPONENTES DO PRODUTO

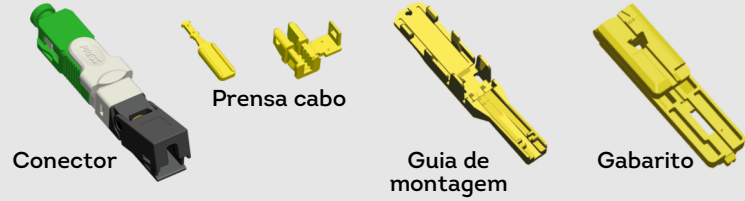

ETAPAS DE MONTAGEM

1 Preparação do conector

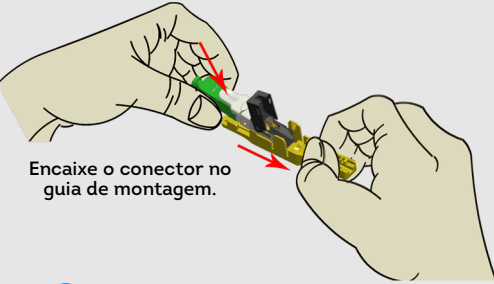

2 Remova a capa do cabo

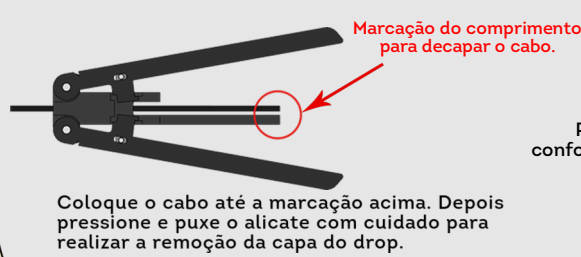

3 Remova o revestimento da fibra

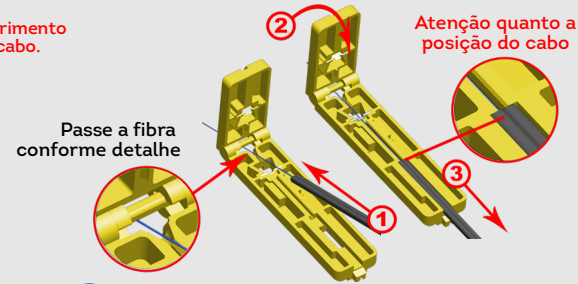

4 Verificar conformidade na fibra

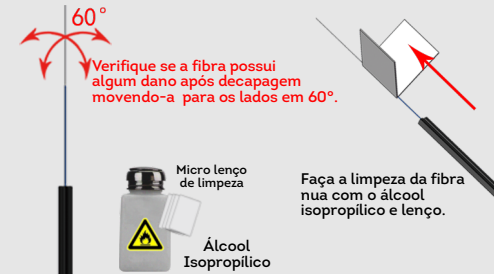

5 Travando a fibra no gabarito

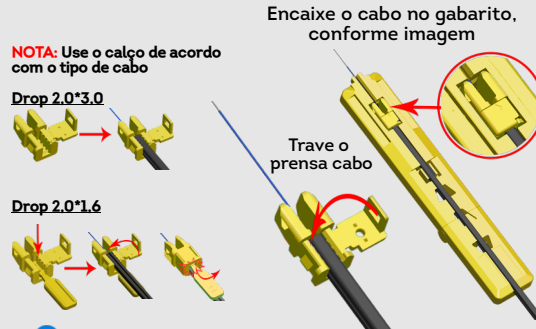

6 Clivando a fibra

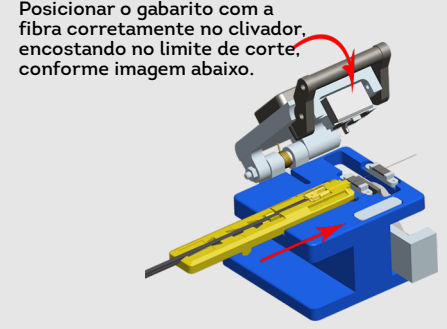

7 Comprimento de corte

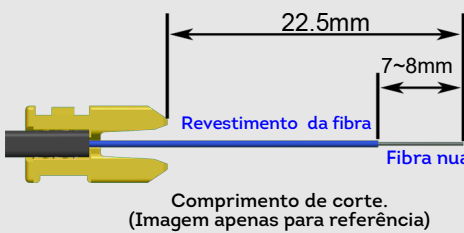

8 Verificar comprimento da fibra

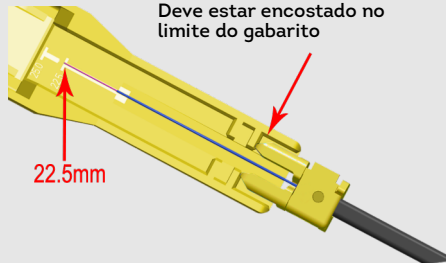

9 Insira a fibra no gabarito

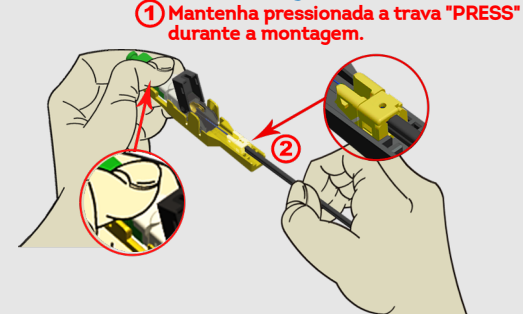

10 Conferir a fibra

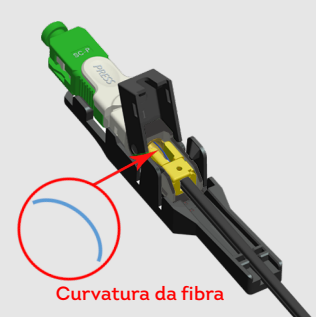

11 Travando a fibra no conector



REUTILIZANDO O CONECTOR

